

## Turbine Flowmeter

# Supmea

### Headquarters

5th floor, Building 4, Singapore Hangzhou Science Technology Park, No. 6 street,  
Hangzhou Economic Development Area, Hangzhou 310018, China

### Singapore

2 Venture Drive #11-30 Vision Exchange Singapore

✉ [info@supmea.com](mailto:info@supmea.com)

🌐 [www.supmea.com](http://www.supmea.com)

Supmea Automation Co.,Ltd.

---

## **Preface**

- Thank you for purchasing our product.
- This manual is about the various functions of the product, wiring methods, setting methods, operating methods, troubleshooting methods, etc.
- Please read this manual carefully before operation, use this product correctly to avoid unnecessary losses due to incorrect operation.
- After you finish reading, please keep it in a place where it can be easily accessed at any time for reference during operation.

## **Note**

- Modification of this manual's contents will not be notified as a result of some factors, such as function upgrading.
- We try our best to guarantee that the manual content is accurate, if you find something wrong or incorrect, please contact us.
- The content of this manual is strictly prohibited from reprinting or copying.

## **Version**

U-ZWLLWGY-MYEN1

---

## Safety Precautions

In order to use this product safely, be sure to follow the safety precautions described.

### About this manual

- Please submit this manual to the operator for reading.
- Please read the operation manual carefully before applying the instrument. On the precondition of full understanding.
- This manual only describes the functions of the product. The company does not guarantee that the product will be suitable for a particular use by the user.

### Precautions for protection, safety and modification of this product

- To ensure safe use of this product and the systems it controls, Please read carefully the operation manual and understand the correct application methods before putting into operation, to avoid unnecessary losses due to operation mistakes. If the instrument is operated in other ways not described in the manual, the protections that the instrument give may be destroyed, and the failures and accidents incurred due to violation of precautions shall not be borne by our company.
- When installing lightning protection devices for this product and its control system, or designing and installing separate safety protection circuits for this product and its control system, it needs to be implemented by other devices.
- If you need to replace parts of the product, please use the model specifications specified by the company.
- This product is not intended for use in systems that are directly related to personal safety. Such as nuclear power equipment, equipment using radioactivity, railway systems, aviation equipment, marine equipment, aviation equipment and medical equipment. If applied, it is the responsibility

---

of the user to use additional equipment or systems to ensure personal safety.

- Do not modify this product. The following safety signs are used in this manual:



Hazard, if not taken with appropriate precautions, will result in serious personal injury, product damage or major property damage.



Warning: Pay special attention to the important information linked to product or particular part in the operation manual.



- Confirm if the supply voltage is consistent with the rated voltage before operation.
- Do not use the instrument in a flammable and combustible or steam area.
- To prevent from electric shock, operation mistake, a good grounding protection must be made.
- Thunder prevention engineering facilities must be well managed: the shared grounding network shall be grounded at is-electric level, shielded, wires shall be located rationally, SPD surge protector shall be applied properly.
- Some inner parts may carry high voltage. Do not open the square panel in the front except our company personnel or maintenance personnel acknowledged by our company, to avoid electric shock.
- Cut off electric powers before making any checks, to avoid electric shock.
- Check the condition of the terminal screws regularly. If it is loose, please tighten it before use.
- It is not allowed to disassemble, process, modify or repair the product without authorization, otherwise it may cause abnormal operation, electric shock or fire accident.
- Wipe the product with a dry cotton cloth. Do not use alcohol, benzene

---

or other organic solvents. Prevent all kinds of liquid from splashing on the product. If the product falls into the water, please cut off the power immediately, otherwise there will be leakage, electric shock or even a fire accident.

- Please check the grounding protection status regularly. Do not operate if you think that the protection measures such as grounding protection and fuses are not perfect.
- Ventilation holes on the product housing must be kept clear to avoid malfunctions due to high temperatures, abnormal operation, shortened life and fire.
- Please strictly follow the instructions in this manual, otherwise the product's protective device may be damaged.



- Do not use the instrument if it is found damaged or deformed at opening of package.
- Prevent dust, wire end, iron fines or other objects from entering the instrument during installation, otherwise, it will cause abnormal movement or failure.
- During operation, to modify configuration, signal output, startup, stop, operation safety shall be fully considered. Operation mistakes may lead to failure and even destruction of the instrument and controlled equipment.
- Each part of the instrument has a certain lifetime, which must be maintained and repaired on a regular basis for long-time use.
- The product shall be scrapped as industrial wastes, to prevent environment pollution.
- When not using this product, be sure to turn off the power switch.
- If you find smoke from the product, smell odor, abnormal noise, etc., please turn off the power switch immediately and contact the company in time.

## Disclaimer

- The company does not make any guarantees for the terms outside the scope of this product warranty.
- This company is not responsible for damage to the instrument or loss of parts or unpredictable damage caused directly or indirectly by improper operation of the user.

## Package contents

Serial number	Item Name	Quantity
1	Turbine Flow meter	1
2	Manual	1
3	Certificate	1

After opening the box, please confirm the package contents before starting the operation. If you find that the model and quantity are incorrect or there is physical damage in appearance, please contact us.

---

## Content

Chapter 1 Product Overview.....	- 1 -
Chapter 2 Working Principle.....	- 2 -
Chapter 3 Technical Parameters.....	- 3 -
Chapter 4 Model Selection.....	- 4 -
4.1 Body connection mode.....	- 4 -
4.2 Nominal diameter.....	- 4 -
4.3 Converter.....	- 5 -
4.4 Accuracy Level.....	- 5 -
4.5 Communication.....	- 5 -
4.6 Attachment.....	- 5 -
4.7 Hygienic.....	- 5 -
Chapter 5 Precautions for Installation and Operation.....	- 7 -
Chapter 6 Wiring.....	- 14 -
6.1 Converter without display.....	- 14 -
6.2 Converter with local display.....	- 16 -
Chapter 7 Parameter setting.....	- 18 -
7.1 Parameter setting.....	- 18 -
7.1.1 Parameter setting.....	- 18 -
7.1.2 Display contents.....	- 18 -
7.1.3 K coefficient setting.....	- 18 -
7.1.4 Weak signal filter setting .....	- 19 -
7.1.5 4-20mA output corresponds to upper limit setting of full flow ..	- 20 -
7.1.6 Sampling period setting.....	- 21 -
7.1.7 Cumulative flow reset setting.....	- 22 -
Chapter 8 Troubleshooting.....	- 23 -





## **Chapter 1 Product Overview**

Based on the principle of torque balance, the liquid turbine flowmeter belongs to the velocity flow meter. It has the advantages of high accuracy, good repeatability, simple structure, small pressure loss and convenient maintenance. It is used to measure the volume flow of low viscosity liquid in closed pipeline. It is widely used in petroleum, chemical, metallurgy, water supply, paper-making and other industries.

The liquid turbine flowmeter is suitable for measuring the liquid in the closed pipe, which has no corrosive effect with stainless steel 1Cr18Ni9Ti, 2Cr13, corundum Al<sub>2</sub>O<sub>3</sub> and cemented carbide which has no fiber, particle and other impurities.

## Chapter 2 Working Principle

The fluid flows through the sensor shell. Because the blade of the impeller has a certain angle with the flow direction, the impulse of the fluid makes the blade have rotation torque. After overcoming the friction torque and fluid resistance, the blade rotates. After the torque is balanced, the speed is stable. Under certain conditions, the speed is proportional to the flow rate. Because the blade has magnetic conductivity, it is in the position of signal detector (composed of permanent magnetic steel and coil) of the magnetic field, the rotating blade cuts the magnetic line of force and periodically changes the magnetic flux of the coil, so that the electric pulse signal is induced at both ends of the coil. The signal is amplified and shaped by the amplifier to form a continuous rectangular pulse wave with a certain amplitude, which can be transmitted to the display meter to display the instantaneous flow or total amount of fluid. In a certain flow range, the pulse frequency  $f$  is proportional to the instantaneous flow  $Q$  of the fluid flowing through the sensor, the flow equation is as follows:

$$Q = 3600 \times \frac{f}{k}$$

Where:

$f$ —Pulse frequency [HZ]

$k$ —Meter coefficient of flowmeter [1/m<sup>3</sup>]

$Q$ —Instantaneous flow rate of fluid (Under working state) [m<sup>3</sup>/h]

3600—Conversion factor

## Chapter 3 Technical Parameters

1. Measuring medium: liquid (water, beverage, lubricating oil, hydraulic oil, organic liquid, inorganic liquid without fiber and particle impurities, etc.);
2. Nominal diameter: DN4-DN200mm;
3. Measurement accuracy: 1.0 %(standard),0.5%;
4. Medium viscosity: less than  $5 \times 10^{-6}$ m<sup>2</sup>/s (for liquids greater than  $5 \times 10^{-6}$ m<sup>2</sup>/s, it is necessary to calibrate the flowmeter with solid liquid)
5. Nominal pressure: 1.0MPa, 1.6Mpa, 2.5MPa, 4.0Mpa, 6.3MPa (customized)
6. Medium temperature: -20 °C ~ + 120 °C (stainless steel pipe);
7. The operating environment conditions: the ambient temperature is -20 °C ~ + 60 °C; the relative humidity is 5% ~ 95%; the atmospheric pressure is 86kpa ~ 106kpa;
8. Power supply: 3.6V lithium battery; 24VDC;
9. Signal output: three wires pulse output, two wires 4-20mA output, three wires 4-20mA output, four wires 4-20mA output;
10. Ingress protection: IP65;
11. Communication mode: RS485 Modbus;

## Chapter 4 Model Selection

LWGY- 

A	B
---	---

 - 

C	D	E
---	---	---

 - 

F	G	H
---	---	---

### 4.1 Body connection mode

1. Threaded connection (DN4 ~ DN50)
2. Flange connection (DN4 ~ DN200)
3. Clamp connection (DN4 ~ DN80)

### 4.2 Nominal diameter

Code	Diameter	Flow range (standard range)
004	DN4	0.04~0.25m <sup>3</sup> /h
006	DN6	0.1~0.6 m <sup>3</sup> /h
010	DN10	0.2~1.2 m <sup>3</sup> /h
015	DN15	0.6~6m <sup>3</sup> /h
020	DN20	0.7~7 m <sup>3</sup> /h
025	DN25	1~10 m <sup>3</sup> /h
032	DN32	1.5~15 m <sup>3</sup> /h
040	DN40	2~20 m <sup>3</sup> /h
050	DN50	4~40 m <sup>3</sup> /h
065	DN65	7~70 m <sup>3</sup> /h
080	DN80	10~100 m <sup>3</sup> /h
100	DN100	20~200 m <sup>3</sup> /h
125	DN125	25~250 m <sup>3</sup> /h
150	DN150	30~300 m <sup>3</sup> /h
200	DN200	80~800 m <sup>3</sup> /h

### **4.3 Converter**

1. No display: pulse output (24 VDC power supply)
2. No display: 4-20mA output (24 VDC power supply)
3. Local display: without output (powered by 3.6V lithium battery)
4. Local display: pulse output (24 VDC power supply)
5. Local display: 4-20mA output (24 VDC power supply)
6. Local display: pulse output (3.6V lithium battery and 24 VDC power supply)
7. Local display: 4-20mA output (3.6V lithium battery and 24 VDC power supply)

### **4.4 Accuracy Level**

1. 1% (standard)
2. 0.5%

### **4.5 Communication**

0. No communication
1. RS485

### **4.6 Attachment**

0. Without
1. With

### **4.7 Hygienic**

0. No
1. Yes

Note:

1. DN4-DN10 diameter flowmeter is equipped with front and back straight pipe section and filter when leaving factory.
2. The material of the measuring tube of the flowmeter is 304 stainless steel, 2Cr13, and the material of the impeller is stainless steel or dual phase steel. The measuring medium shall not corrode stainless steel 1Cr18Ni9Ti, 2Cr13, corundum Al<sub>2</sub>O<sub>3</sub> and cemented carbide. If it is corrosive medium, it must be noted when ordering.
3. Other models are customized.

## Chapter 5 Precautions for Installation and Operation

### (1) Schematic diagram of whole structure

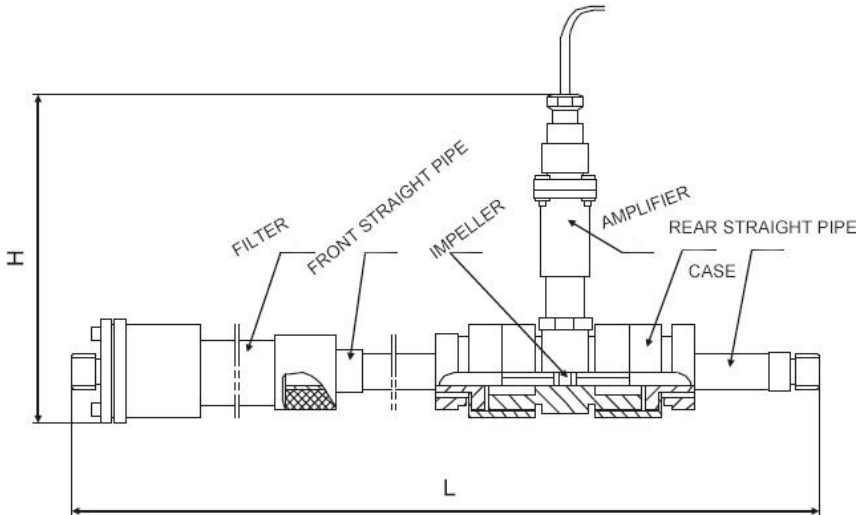

1.Filter 2. Front straight pipe 3. Impeller 4. Amplifier 5. Case 6. Rear straight pipe

Figure 1 Schematic diagram of whole structure

### (2) Installation dimensions

The flowmeter can be divided into threaded connection, flange connection and clamp connection according to the connection mode of meter body. See Fig. 2, Fig. 3 and Fig. 4 for structural diagram. See table 1, table 2 and table 3 for installation dimensions.

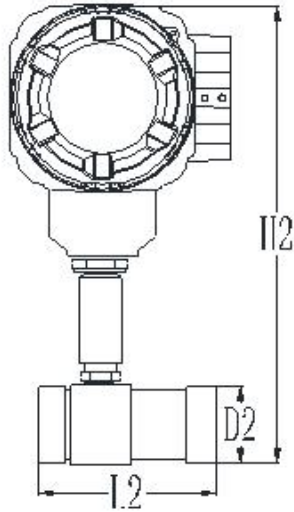

Figure 2 Threaded connection type

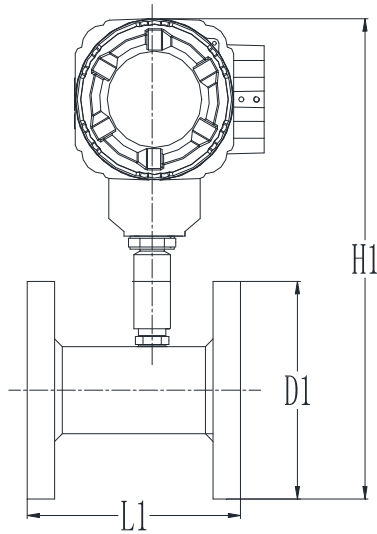

Figure 3 Flange connection type



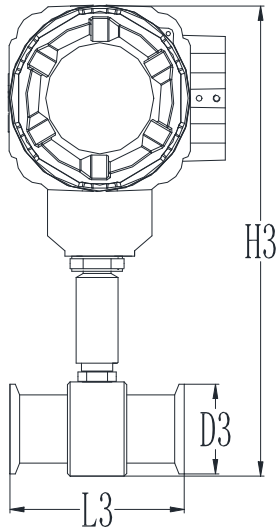

Figure 4 Sanitary clamp connection

Note: because of different amplifiers, the whole meter structure diagram is different, and Fig. 1 is the amplifier connector; Fig. 2, 3 and 4 are LCD amplifiers.

**Flange connection type installation dimension**

**Table 1**

Flange connection type						
Diame ter	Flange diameter D1	Meter body length L1	Center distance of flange bolt hole	Flange bolt hole	Maximum height of the whole meter H1	Hirschmann joint height H1
DN4	DN15 Flange 95	310(including front and rear straight pipe sections and filters)	65	4-Ø14	295	215

DN6	DN15 Flange 95	310(including front and rear straight pipe sections and filters)	65	4-Ø14	300	215
DN10	DN15 Flange 95	430(including front and rear straight pipe sections and filters)	65	4-Ø14	300	215
DN15	95	75	65	4-Ø14	300	215
DN20	105	85	75	4-Ø14	310	225
DN25	115	100	85	4-Ø14	315	230
DN32	140	140	100	4-Ø18	330	245
DN40	150	140	110	4-Ø18	340	255
DN50	165	150	125	4-Ø18	355	270
DN65	185	180	145	4-Ø18	370	285
DN80	200	200	160	8-Ø18	385	300
DN100	220	220	180	8-Ø18	405	320
DN125	250	250	210	8-Ø18	430	345
DN150	285	300	240	8-Ø22	465	380
DN200	340	360	295	12-Ø22	515	430

Note:

1. The length of flange connection meter body refers to the distance between the outermost end faces of two flanges in the meter body;
2. The length of DN4-DN10 meter body is the length including the front and rear straight pipe sections and the filter; Due to the large number of connectors, the size is slightly deviated;
3. As there are many kinds of amplifiers, the height of the whole meter is the maximum height, and the others are subject to the real object.

**Threaded connection type installation dimension Table 2**

Screw connection type				
Diameter	Thread size D2	Meter length L2	maximum height of the whole meter	Hirschmann joint heightH2

DN4	G1/2	310(including front and rear straight pipe sections and filters)	265	190
DN6	G1/2	310(including front and rear straight pipe sections and filters)	265	190
DN10	G1/2	430(including front and rear straight pipe sections and filters)	265	190
DN15	G1	75	275	200
DN20	G1	85	275	200
DN25	G5/4	100	285	210
DN32	G1 1/2	140	290	215
DN40	G2	140	300	225
DN50	G2 1/2	150	315	240

Note:

1. The length of thread connection meter body refers to the distance between the outermost end faces of two threads in the meter body;
2. The length of DN4-DN10 meter body is the length of the front and back straight pipe sections and the filter;
3. As there are many kinds of amplifiers, the height of the whole meter is the maximum height, and the others are subject to the real object.

**Clamp connection type installation dimension Table 3**

Sanitary connecting type				
Diameter	Chuck OD dimension D3	Length of meter body L3	Maximum height of the whole meter H3	Hirschmann joint heightH3
DN4	50.5	380(including front and rear straight pipe sections and filters)	290	205
DN6	50.5	380(including front and rear straight pipe sections and filters)	290	205
DN10	50.5	500(including front and rear straight pipe sections and filters)	290	205
DN15	50.5	75	290	205
DN20	50.5	85	290	205
DN25	50.5	100	290	205

DN3 2	50.5	140	290	205
DN4 0	63.5	140	300	215
DN5 0	77	150	315	230
DN6 5	91	180	330	245
DN8 0	106	200	345	260

**Note:**

1. The length of quick clamp connecting the meter body refers to the distance between the outermost end faces of two clamps in the meter body;
2. The length of DN4-DN10 meter body is the length including the front and rear straight pipe sections and the filter;
3. As there are many kinds of amplifiers, the height of the whole meter is the maximum height, and the others are subject to the real object.

**(3) Installation cautions**

1. The flowmeter should be far away from the external electric field and magnetic field.
2. The flowmeter can be installed horizontally and vertically, and the flow direction must be upward when it is installed vertically. During installation, the liquid flow direction shall be consistent with the direction of the arrow indicating the flow direction on the flowmeter shell.
3. The upstream of the flowmeter shall have a straight pipe section at least 10 times of the nominal diameter, and the downstream end shall have a straight pipe section at least 5 times of the nominal diameter. The inner wall of straight pipe section shall be smooth and clean, without dent, scale, peeling and other defects. The pipe axis of the sensor shall be aligned with the adjacent pipe axis, and the gasket used for connection and sealing shall not extend into the inner cavity of the pipe.
4. When there are impurities in the fluid, a filter should be installed. The mesh size of the filter depends on the impurities in the flow, generally 20-60 mesh. When the fluid is mixed with free gas, the degasser should be installed. The whole piping

system shall be well sealed.

5. When the flowmeter is installed outside, please waterproof the amplifier and plug.

6. When the flowmeter starts to use, the flow sensor should be slowly filled with liquid, and then open the outlet valve. It is strictly forbidden to be impacted by high-speed fluid when the sensor is in no liquid state.

7. In order not to affect the normal transmission of liquid during maintenance, it is recommended to install bypass pipe at the installation place of sensor.

8. Users should fully understand the corrosion of the measured medium and strictly prevent the sensor from corrosion.

## Chapter 6 Wiring

### 6.1 Converter without display

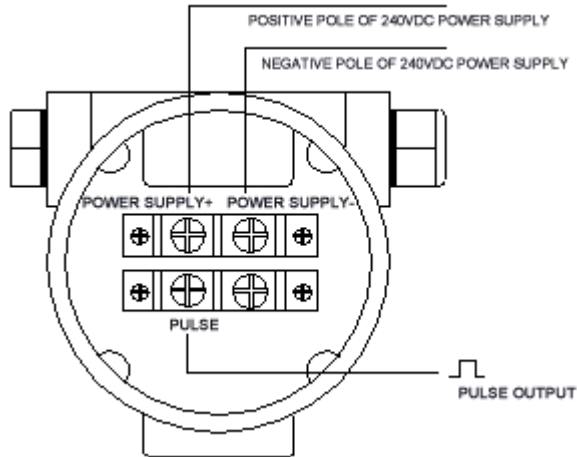

Note: when the negative pole of external 24 VDC power supply and the negative pole of pulse input are not grounded in common, the two (i.e. K5 plug-in block) should be short circuited.

**Figure 5 Converter with pulse output**

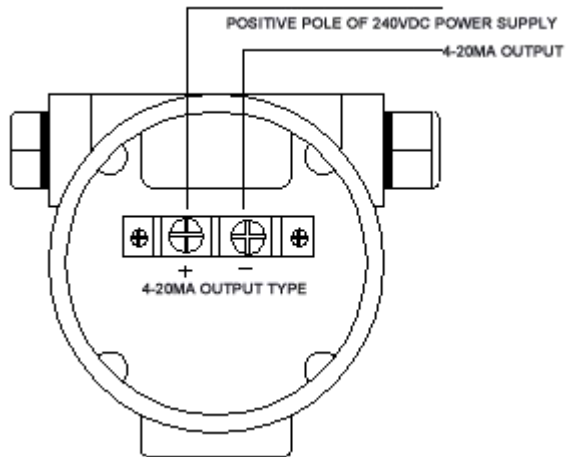

Note: when the output signal is connected to the computer system, the K5 plug-in block at the upper front of the circuit board should be disconnected.

**Figure 6 Converter with 4-20mA output**

## 6.2 Converter with local display

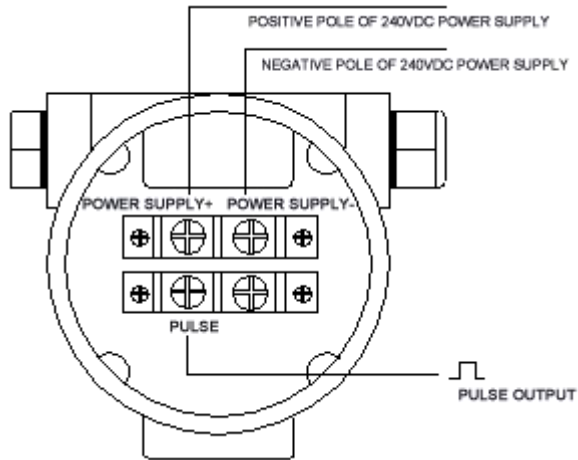

Note: when the negative pole of external 24 VDC power supply and the negative pole of pulse input are not grounded in common, the two (i.e. pulse (secondary meter) plug-in block) should be short circuited.

**Figure 7 Converter with pulse output**



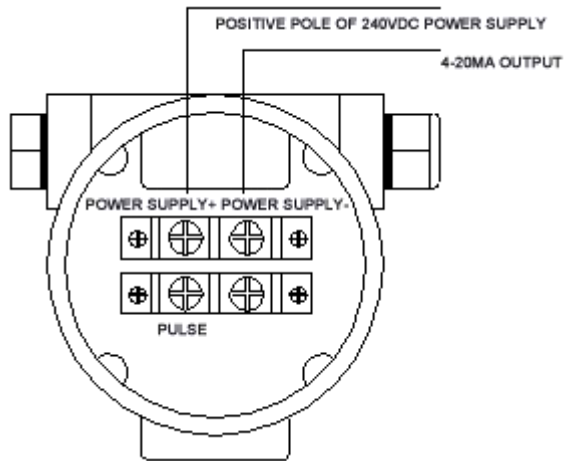

Note: when the output signal is connected to the computer system, the top side of the circuit board (i.e. pulse (secondary meter) plug-in block) should be disconnected.

### Figure 8 Converter with 4-20mA output

Warning: the meter must be operated after power off while wiring

## Chapter 7 Parameter setting

### 7.1 Parameter setting

#### 7.1.1 Parameter setting

The intelligent field display amplifier can display the instantaneous flow and cumulative flow at the same time. The current output amplifier can set and modify the upper limit value of the flow meter directly by pressing the key, without readjusting the zero point and full degree.

The specific parameter settings are set through the function key Z, number increase key ↑, shift key → cooperation. Finally, the Z key must be continuously pressed to cycle display to "END", and then press Z to confirm.

The setting method and display contents are as follows:

#### 7.1.2 Display contents

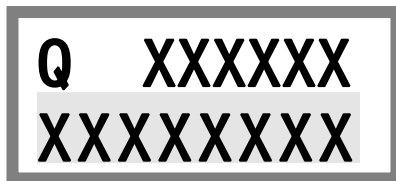

1. The first line is marked with Q to represent the instantaneous flow, and its value is six floating-point display.

Display range: 0 - 999999.

2. The second line is cumulative flow display, and its value is eight floating-point display.

Display range: 0-99999999.

#### 7.1.3 K coefficient setting

Press the function key Z to display the sign as follows:



Then the meter coefficient K is displayed as follows:

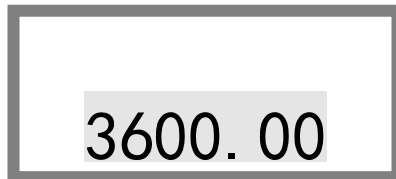

The meter coefficient of up to six integers and two decimals can be set through the number increase key  $\uparrow$ , shift key  $\rightarrow$ . After confirming that the input is correct, press the function key Z to place the parameter. The meter coefficient is set in the range of 0.00-999999.99

If the instantaneous flow unit is required to be displayed as L/h, the coefficient unit of the meter should be 1/L; if the instantaneous flow unit is required to be displayed as m<sup>3</sup>/h, the coefficient unit of the meter should be 1/ m<sup>3</sup>.

Note: if the diameter of the flowmeter is less than DN32, the default setting of the meter coefficient is 1/L, that is, the instantaneous flow display unit is L/h; if the diameter of the flowmeter is greater than or equal to DN32, the default setting of the meter coefficient is 1/m<sup>3</sup>, that is, the instantaneous flow display unit is m<sup>3</sup>/h.

#### **7.1.4 Weak signal filter setting (unit: corresponding to instantaneous flow)**

Press the function key Z twice to continuously display the sign as follows:

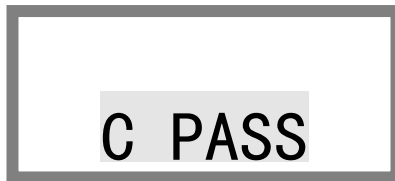

C PASS



SET CUT

Then the small signal cut off value is displayed



.01

You can set the small signal value of 4-digit integer and 2-digit decimal through the number increase key ↑ , shift key → . After confirming that the input is correct, press the function key Z to place the parameter. The minimum cut off value is 0.01.

**7.1.5 4-20mA output corresponds to upper limit setting of full flow (unit is the same as instantaneous flow unit)**

Press the function key Z three times to continuously display the sign as follows:

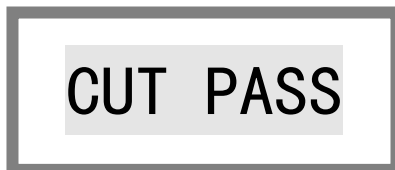

CUT PASS



FL--

Then display the upper limit value of full flow

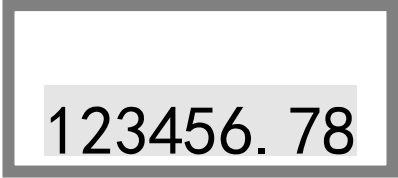

123456.78

You can use the number increase key  $\uparrow$ , shift key  $\rightarrow$  to arbitrary modify, set six integers and two decimal full flow upper limit value. After confirming that the input is correct, press the function key Z to place the parameter (this parameter can not be set when pulse output or no current output) continuous display.

The sign is as follows. Press Z to exit the setting status and return to the work interface.



FL-PASS

### 7.1.6 Sampling period setting

Press the function key Z until the flashing sign is as follows:



END

Then press the key Z, key ↑, key → at the same time and stop after 3 seconds.

The LCD screen will cycle display the following sign:

A rectangular LCD screen with a grey border. In the center, the text "CYCLE 10''" is displayed in a bold, black, sans-serif font. The text is centered horizontally and vertically within the screen.

A rectangular LCD screen with a grey border. In the center, the text "CYCLE 5''" is displayed in a bold, black, sans-serif font. The text is centered horizontally and vertically within the screen.

A rectangular LCD screen with a grey border. In the center, the text "CYCLE 2''" is displayed in a bold, black, sans-serif font. The text is centered horizontally and vertically within the screen.

They represent the sampling time of 10 seconds, 5 seconds and 2 seconds respectively. After selecting the appropriate sampling time, press the function key Z to confirm. The shorter the sampling time, the shorter the battery life. So in general, the maximum sampling time should be 10 seconds.

#### **7.1.7 Cumulative flow reset setting**

Press the function key Z until the flashing sign is as follows:

A rectangular LCD screen with a grey border. In the center, the text "END" is displayed in a bold, black, sans-serif font. The text is centered horizontally and vertically within the screen.

At the same time, press the key Z, key → 5 seconds to stop, and the LCD screen will display the accumulated flow value as follows:

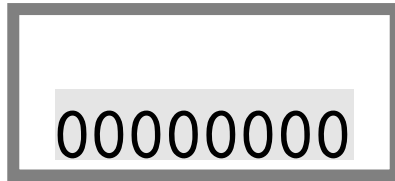

Press the function key Z to confirm clearing. If you do not want to clear, press shift key → to return.

## Chapter 8 Troubleshooting

See the table below for the possible general faults of the flowmeter and their elimination methods. It is recommended that the maintenance period should not exceed half a year.

Number	Fault phenomenon	Reason	Elimination method
1	The display meter does not display the flow signal and inspection signal	1. The power supply is not connected, and the given voltage is not correct. 2. The display meter has fault.	Turn on the power and set the voltage as required. Maintain the display meter.

<p>2</p>	<p>The display meter has display on "calibration" signal but does not display the flow signal</p>	<p>there is a wrong connection between the flowmeter and the display meter, or there is an open circuit, short circuit, poor contact and other faults                  The amplifier is faulty or damaged.                  Converter (coil) open circuit or short circuit.                  The impeller is stuck.                  There is no fluid flow or blockage in the pipeline.</p>	<p>Check the correctness and quality of wiring.                  Repair or replace the amplifier.                  Repair or replace the coil.                  Clean the sensor and pipeline. Open the valve or pump and clean the pipeline.</p>
<p>3</p>	<p>The display meter is unstable or incorrect measurement</p>	<p>The actual flow exceeds the measuring range of the meter or unstable.                  The meter coefficient K is set incorrectly.                  Fiber and other impurities are hung in the sensor.                  There are bubbles in the liquid.                  There is strong electromagnetic interference near the</p>	<ol style="list-style-type: none"> <li>1. Make the measured flow adapt to the measuring range of the flowmeter and stabilize the flow.</li> <li>2. Make the coefficient K set correctly.</li> <li>3. Clean the sensor.</li> <li>4. Take degassing measures to eliminate bubbles.</li> <li>5. Keep away from</li> </ol>



		<p>flowmeter.</p> <p>The sensor bearing and shaft are seriously worn.</p> <p>The shielding layer of flowmeter cable or other grounding wires are disconnected from the line ground wire or have poor contact.</p> <p>Display meter fault.</p>	<p>interference sources or take shielding measures.</p> <p>6. Replace the "guide part" or "impeller shaft".</p> <p>7. Connect the wires according to the wiring diagram.</p> <p>8. Maintain the display meter.</p>
--	--	---	--